



STEP 1 – PRIOR TO INSTALLATION

- A) Bushwacker only approves installing the flares according to these written instructions with the hardware provided. WARNING:** Failure to install according to these instructions will invalidate the warranty. This includes, but is not limited to using alternative installation methods, hardware, or materials. **DO NOT USE:** Loctite, SuperGlue, or similar products on the hardware or the flares.
- B) Fit:** Verify the fit of the flares to vehicle. (Some filing, sanding, or cutting may be necessary to ensure proper fit).
- C) Painting:** (Optional) if paint is desired it must be done prior to installing flares on vehicle. Clean outer surface with a good grade degreaser. **DO NOT USE LACQUER THINNER OR ENAMEL REDUCER AS A DEGREASER.** Wipe outer surface thoroughly with a tack rag prior to paint. Application of plastic adhesion promoter for ABS plastic as per your paint system manufacturer's recommendations is required. Paint flares using a high quality enamel, or polyurethane automotive paint. If painting edge trim (not recommended), use a flex additive.
- D) Performance:** Using larger Tires may increase the area required to turn the vehicle. Some Tire/Rim combinations may require lowering bump stops and or installing steering stops to prevent tire from contacting flare.
- E) Exhaust System:** Modifications may be necessary to maintain a minimum 4" clearance between flares and exhaust pipes. (Exhaust gases should not vent directly onto flares)
- F) Metal Protection:** All exposed fasteners and bare metal should be treated with rust resistant paint **BEFORE** installing flares. Spray inner fender wells with undercoating **AFTER** flare attachments have been completed.
- G) Decals:** Flares may interfere with existing decals on vehicle. If you wish, remove decals prior to installation of flares.
- H) Care & Cleaning:** Bushwacker fender flares are built to last; any detergent you use to wash your vehicle is sufficient to clean the flare. Do not use any harsh abrasive detergents.

GMC Pocket Style® Fender Flares Set of 4

Set Part #40972-02

Rev-0 4/28/2016

For complete fitment information and full color installation instructions visit:
www.bushwacker.com

TOOLS FOR EASY INSTALLATION:











- Awl
- #2 Phillips Screwdriver
- Grease Pencil/Sharpie
- Pliers
- Socket Wrench
- 10mm Socket
- T-15 Torx Bit
- Torx Bit Driver
- Soft Wiping Cloth

PLEASE READ: Dirt and debris can become lodged between the fender flares and the vehicle's fenders, causing scratching and paint wear from vibration. Lund International is not responsible for any damage, and the installation of our fender flares is done with the buyer's understanding that this scratching and paint wear may occur.

LIMITED LIFETIME WARRANTY AGAINST ANY MANUFACTURING DEFECTS

- To claim a warranty, you must provide Proof of Purchase.

Included in Hardware Kit:

- | | | | | | | | | | | | | | |
|----|--|----|---|-----|---|----|---|----|--|----|---|----|---|
| 1. |  | 2. |  | 3. |  | 4. |  | 5. |  | 6. |  | 7. |  |
| | SW1-0056,
#8 x 3/4"
PH Screw,
32 pcs | | SW1-0067,
5/16 x 18 x 3/8"
SS Torx Screw,
36 pcs | | WA1-0012,
.320 x .700 x .03
SS Washer,
36 pcs | | NU1-0019,
5/16-18 Jam Fin.
Nylock Nut,
36 pcs | | SW1-0052,
T-45 Torx Bit,
1 pc | | CL1-0009,
Long "U" Clip,
Magni 565
12 pcs | | CL1-0028,
Small "U" Clip
Wide Mouth,
10 pcs |
| 8. |  | 9. |  | 10. |  | | | | | | | | |
| | MT1-0034,
1" x 1.5" x .06"
Blk 3M Foam Tab,
12 pc | | GP1-0025,
EX4008 Wiper
Style Edge Trim,
344 inches | | ET1-0002,
Edge Trim Tool,
1 pc | | | | | | | | |

Components List:

Front Flare x 2



Short Brackets x 2
Driver Side (LF1)
Passenger Side (RF1)

Long Brackets x 2
Driver Side (LF2)
Passenger Side (RF2)

Rear Flare x 2



EDGE TRIM INSTALLATION

A. Peel two to three inches of red vinyl backing away from Edge Trim (GP1-0025) tape. Applying the adhesive side of the edge trim to the inner side of the flare, affix the edge trim to the top edge of the flare (the portion that comes in contact with the vehicle).

B. Press edge trim into place along the top edge of the flare in one-foot increments, pulling red vinyl backing free as you continue to work your way around the top edge of the flare.



Pocket Hardware Installation Procedures:



Put a Washer (WA1-0012) on each Bolt (SW1-0067).



Put each Bolt/Washer combination through a pocket hole in the flare, Bolt head and Washer on the outside.



Place a Nut (NU1-0019) over the end of each Bolt and tighten, using a 1/2" wrench for the Nut and the supplied Torx Bit (SW1-0052) for the Bolt. Repeat for remaining pockets.

Front Flare Installation Procedures (Passenger Side):

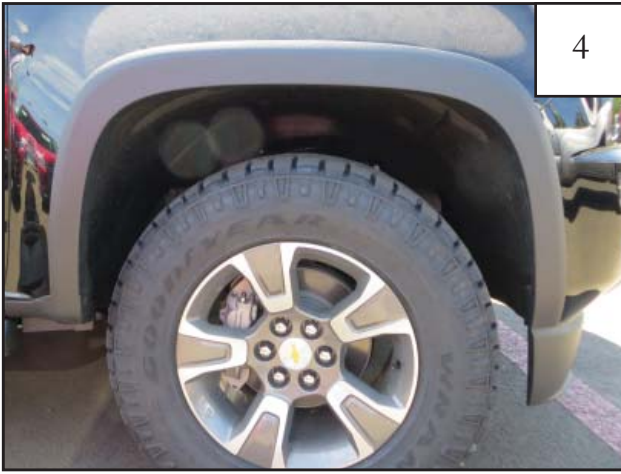

Fitment Note: If factory flares are installed, remove before starting installation. Factory fasteners require a T-15 torx bit.



Using a T-15 torx bit, remove six factory fasteners from wheel well. Retain for bracket installation.



Using a T-15 torx bit, remove two factory fasteners from mud guard. Discard factory fasteners only..

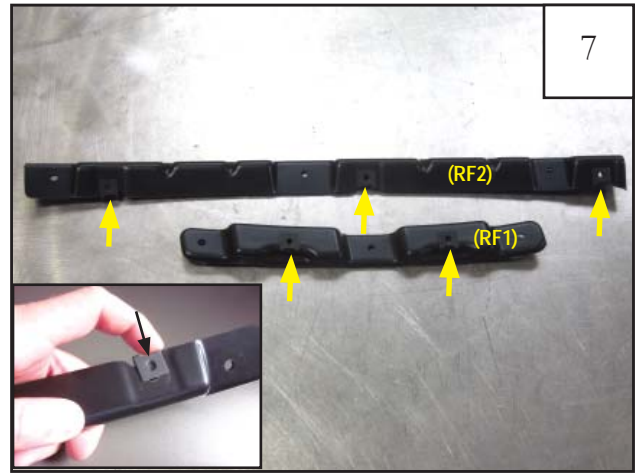

Install three clips (CL1-0028) onto the upper mounting bracket (RF2) and two clips (CL1-0028) onto the front mounting bracket (RF1). Repeat same step for driver side brackets (LF1, LF2).



Install the short mounting bracket (RF1) into front of wheel well, using three factory fasteners and a T-15 torx bit. Tighten screws.



Install the long mounting bracket (RF2) into top of wheel well, using three factory fasteners and a T-15 torx bit. Tighten screws.



10

Holding the flare into position on vehicle, use a grease pencil or sharpie to mark sheet metal using the upper rear hole location as a guide.

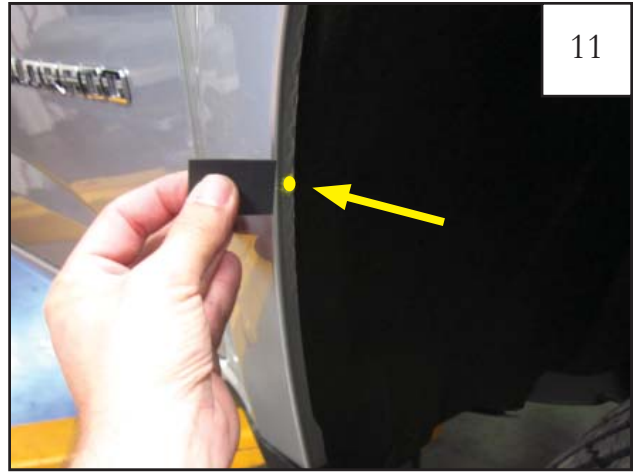

11

Wrap one supplied tab (MT1-0034) around inner lip of sheet metal over the marked location.



12

Once tab has been applied, install one clip (CL1-0009) over tab.



13

Holding flare in position, start five supplied screws (SW1-0056) into the top three and front two holes. Do not fully tighten.



14

Using an awl, align clip with mounting hole and start one supplied screw (SW1-0056). Do not tighten.



15

Start two supplied screws (SW1-0056) into the two bottom rear mounting locations. Fully tighten all screws.

Rear Flare Installation Procedures (Passenger Side):



Using a T-15 torx bit, remove two factory fasteners from the mud guard in the lower rear of the wheel well. Discard factory fasteners only.

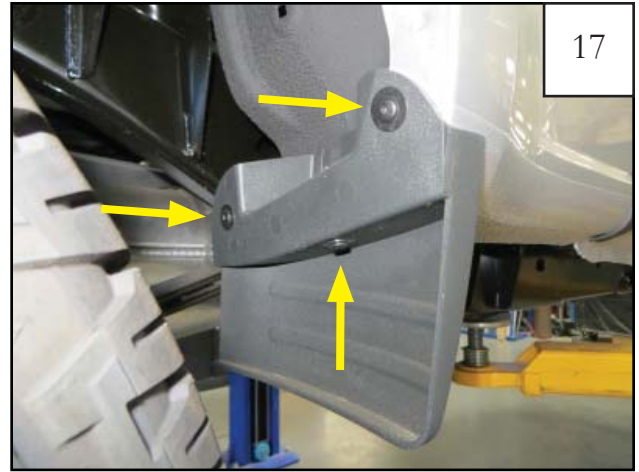

Using a T-15 torx bit, remove three factory fasteners from the deflector located at the lower front of the wheel well.



Once the three factory fasteners have been removed, reach in behind deflector to find white factory retainer. Using pliers, pinch retainer and push towards wheel center, releasing deflector. Discard factory fasteners and deflector.



Holding flare in position, use a grease pencil or sharpie to mark the five upper mounting hole locations using the mounting holes in the flare as a guide. Remove flare.

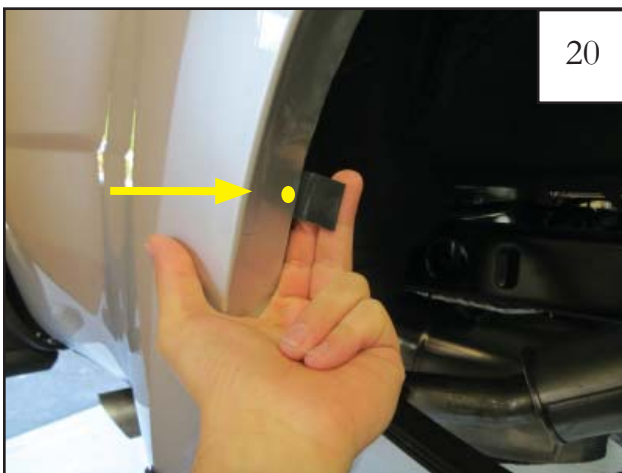

Wrap five supplied tabs (MT1-0034) around inner lip of sheet metal over the marked locations.

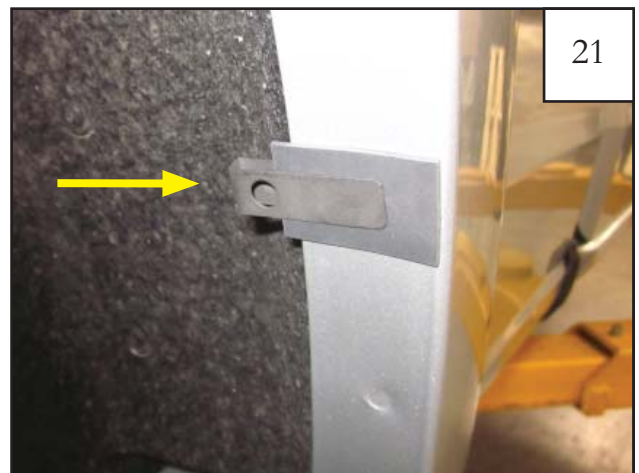

Place one clip (CL1-0009) over each tab.



22

Holding flare in position, start five supplied screws (SW1-0056) starting through the top center hole working outward. Use awl to align clip with mounting hole.



23

Start three supplied screws (SW1-0056) into one forward and two rearward mounting holes. Fully tighten all screws.

Edge Trim Tool Procedures:



24

Using supplied Edge Trim Tool (ET1-0002), seat edge trim against vehicle by hooking curved end under edge trim at one end of flare. Next, slide around outer edge of flare to the other end.



25

Using flat end of supplied Edge Trim Tool (ET1-0002), seat edge trim against flare by inserting straight end between edge trim and flare at one end. Next, slide around entire edge to the other end.